

**CUNETTA O FOSSA DI GUARDIA IN CLS**  
**cm. 80-90x40hx6spx215lg**

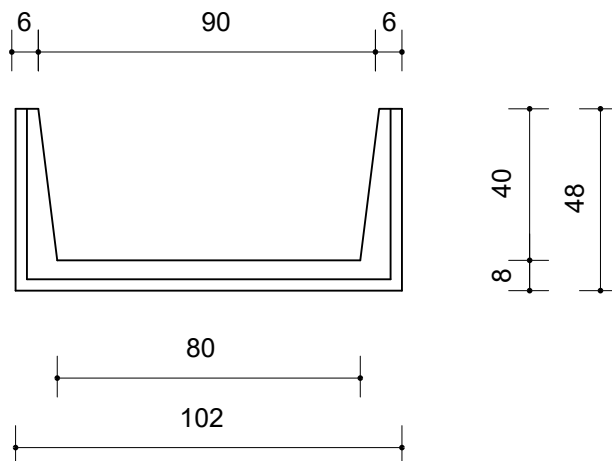
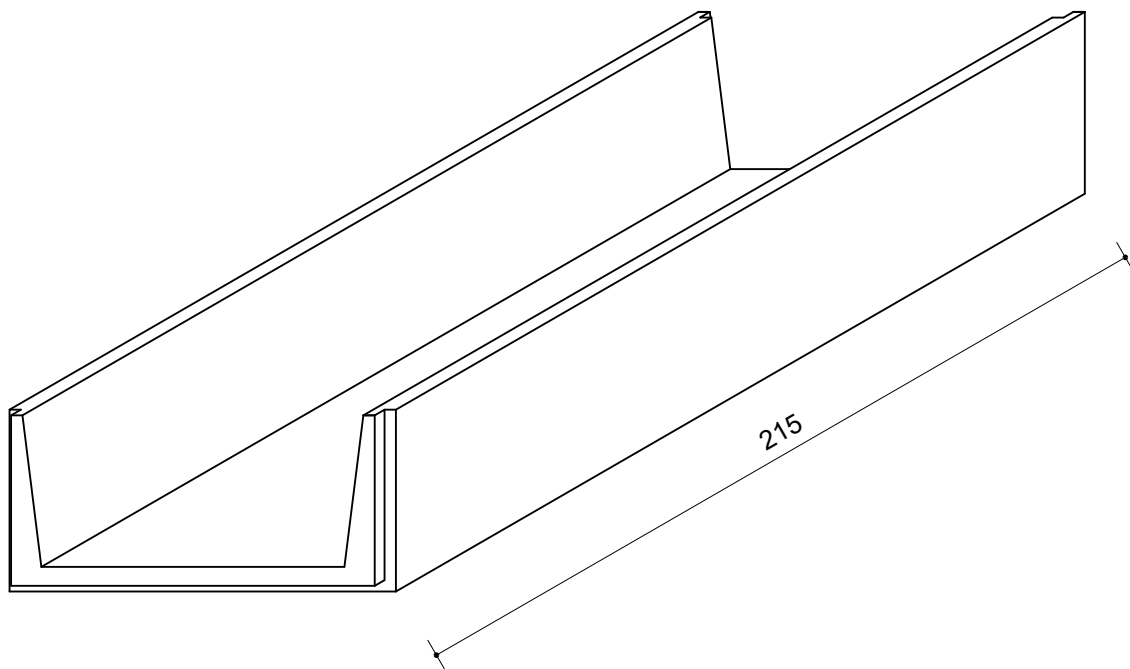

Peso 780 kg  
Tolleranze dimensionali +/- 5 mm